

## CARATTERISTICHE TECNICHE

MOMENTO DI SOLLEVAMENTO	17	Ton/m
BRACCIO MAX. IDRAULICO	5,67	m.
ALTEZZA MAX. IDRAULICA	8,80	m.
BRACCIO MAX. CON PROLUNGHE	9,30	m.
ALTEZZA MAX. CON PROLUNGHE	12,50	m.
ROTAZIONE IDRAULICA	360	Gradi
PENDENZA MAX. DI LAVORO	10	Gradi
VELOCITA' DI ROTAZIONE	30	sec.
PRESSIONE D'ESERCIZIO	280	bar
PORTATA OLIO POMPA	40	L/min.
CAPACITA' SERBATOIO OLIO	100	Lt.
PESO GRU STANDARD	1900	Kg.

## TECHNICAL DATA

LIFTING MOMENT	17	Ton/m.
MAX.HORIZONTAL REACH	5,67	m.
MAX.VERTICAL REACH	8,80	m.
MAX. REACH WITH MAN.EXTENSION	9,30	m.
MAX. HEIGHT WITH MAN.EXTENSION	12,50	m.
SLEWING ANGLE	360	Degrees
MAX. WORKING HEEL	10	Degrees
SLEEWING SPEED	30	sec.
WORKING PRESSURE	280	bar
MAX. OIL FLOW	40	L/min.
OIL TANK CAPACITY	100	Lt.
CRANE WEIGHT	1900	Kg.



Dati, descrizioni e illustrazioni sono indicative e non impegnano il costruttore.

Data, descriptions and illustration are merely indicative and not binding.

BENELLIGRU s.r.l. Via Romana, 27 – 42028 Poggio (RE) ITALY Tel.+39-0522-969756  
Fax. +39-0522-969315 e-mail: commerciale@benelligru.it Web : www.benelligru.it



<b>N.1 BRACCIO ARTICOLATO</b>
<b>N.2 SFILI IDRAULICI</b>
<b>N.2 STABILIZZATORI USCITA IDRAULICA</b>
<b>COMANDI BILATERALI 5 ELEMENTI</b>
<b>PATTINI DI SCORRIMENTO IN BRONZO</b>
<b>SERBATOIO OLIO FORNITO A PARTE</b>
<b>KIT DI MONTAGGIO IN DOTAZIONE</b>
<b>NORMA DI PROGETTAZIONE : DIN 15018</b>
<b>CLASSE : H2 B3</b>
<b>COLORE : ROSSO RAL 2002</b>
<b>DISPOSITIVI DI SICUREZZA ELETTRICI:24V CON LIMITATORE DI MOMENTO E LIMITATORE ARCO ROTAZIONE</b>

<b>N.1 ARTICULATED ARM</b>
<b>N.2 HYDRAULIC EXTENSIONS</b>
<b>N.2 HYDRAULIC STABILIZERS</b>
<b>DUAL CONTROL FIVE LEVELS</b>
<b>BRONZE BUSHING</b>
<b>OIL TANK PROVIDED TO PART</b>
<b>ASSEMBLY KIT IN ENDOWMENT</b>
<b>DESIGN IN ACCORDANCE WITH DIN 15018</b>
<b>CLASSIFICATION : H2 B3</b>
<b>COLOR : RED RAL 2002</b>
<b>ELECTRICAL DEVICES : 24 V WITH MOMENT'S LIMITING DEVICE AND ROTATION ARC LIMITING DEVICE</b>

## ACCESSORI

## ACCESSORIES

<b>PROLUNGHE MECCANICHE</b>
<b>RADIOCOMANDO PROPORZIONALE</b>
<b>STABILIZZATORI GIREVOLI</b>
<b>ATTIVAZIONI SUPPLEMENTARI PER ACCESSORI</b>

<b>MANUAL EXTENSIONS</b>
<b>PROPORTIONAL RADIO CONTROL</b>
<b>TURNING STABILIZERS</b>
<b>SUPPLEMENTARY ELEMENT ACTIVATION</b>

## DIMENSIONI D'INGOMBRO

## OVERALL DIMENSIONS

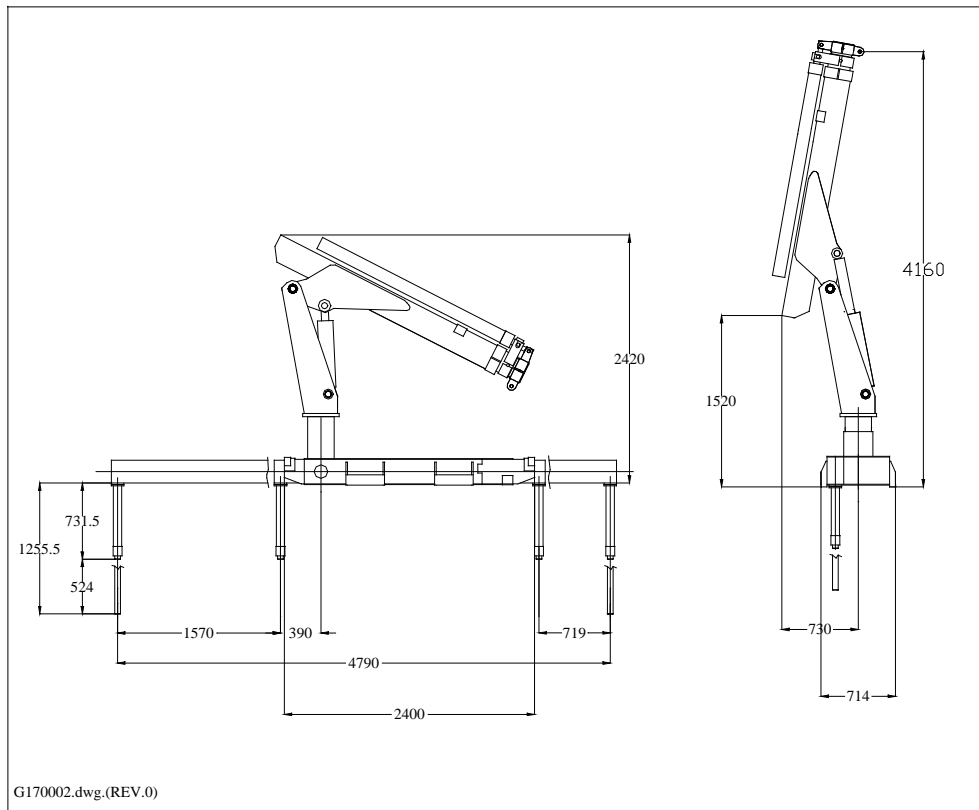

BENELLIGRU s.r.l. Via Romana, 27 – 42028 Poggio (RE) ITALY Tel.+39-0522-969756  
Fax. +39-0522-969315 e-mail: commerciale@benelligru.it Web : www.benelligru.it



FILE: SK170002.DOC (REV.1 DEL 11/05/02)

This document was created with Win2PDF available at <http://www.daneprairie.com>.  
The unregistered version of Win2PDF is for evaluation or non-commercial use only.